

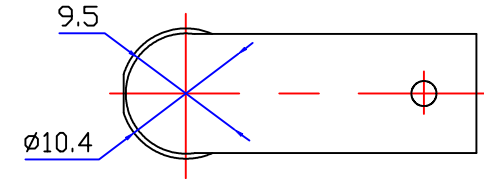

Product NO.	Renhotec-610-0030			
REV	DESCRIPTION	DWN	DATE	APPROVEN
A	First issue	Mr. Wang	2016/3/05	John kine

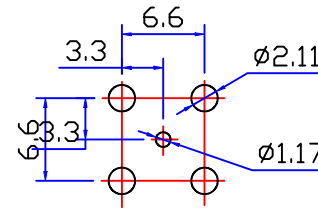
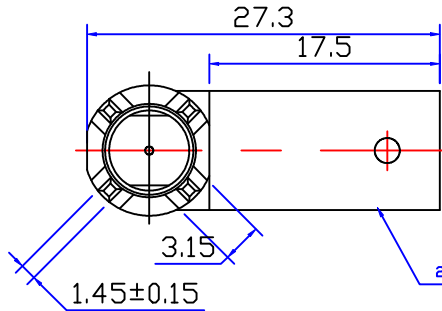
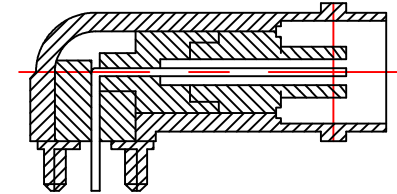
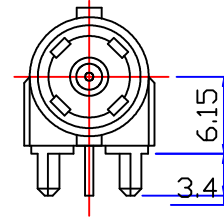
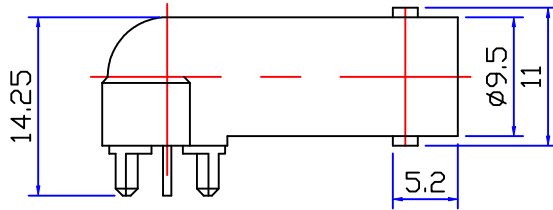

PCB HOLE CONFIGURATION
RECOMMENDED PANEL CUTOUTS

Specification:

Impedance: 50.75 Ohms
VSWR:1.3MAX

Frequency range:DC~4G

Working Voltage:500V rms @ sea level

Insulation resistance:5000 Ohms min

Temperature range:-55°C TO +155°C

Relative temperature:≤95%(40° C±2° C)

Drawings products are in line with ROHS standards.

NOTE:

Tolerance

0-6	±0.10
6-30	±0.20
30-120	±0.30
Angular	±2°



RENHOTEC GROUP

DRAWN
Zelin. Zhang
2016/03/05

View

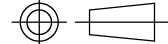

Name: BNC CONNECTOR DNN

CHECKED

UNIT

MM

SIZE A Product NO. RENHOTEC-610-0030

APPROVALS
John Kine
09.03.2016

SCALE

1:1

DateTime
2016/3/05

CAD FILE
D/company drawings/BD

SHEET: 1 OF 1

3	BODY	ZINC	NICKEL	1
2	INSULATOR	POM	WHITE	1
1	PIN	BRASS	GOLD	1
NO	DESCRIPTION	MATERIAL	FINISH	QTY