

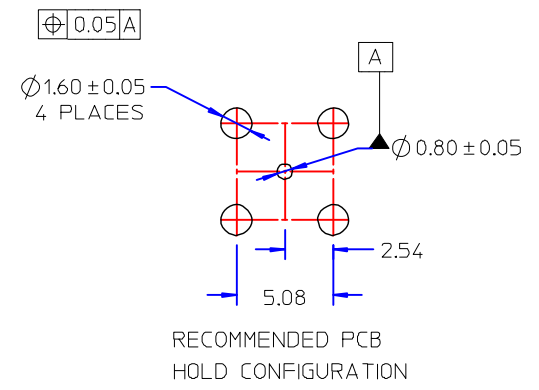

| | | | | |
|-------------|-------------|----------------|------------|-----------|
| Product NO. | | DOSIN-807-0011 | | |
| REV | DESCRIPTION | DWN | DATE | APPROVEN |
| A | First issue | JIM | 2012/11/02 | John kine |

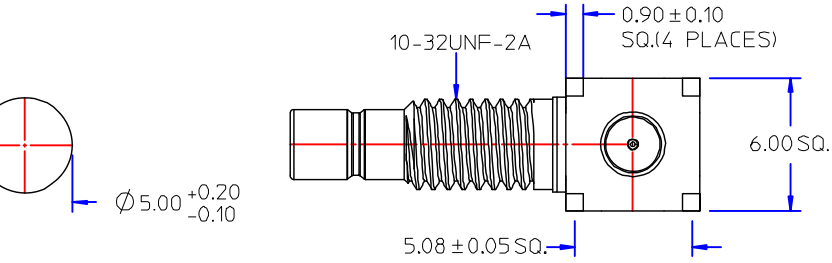
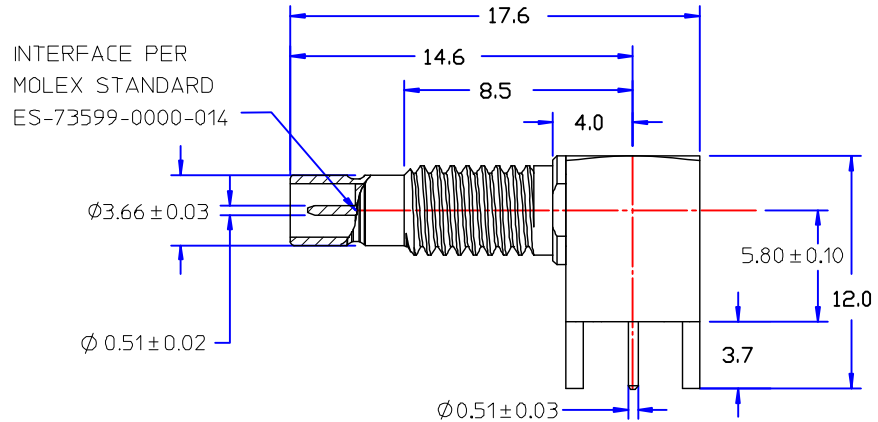
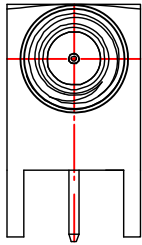

MATERIALS AND FINISHES
CONNECTOR BODY BRASS
PLATED GOLD

CENTER CONTACT PHOSPHOR BRONZE
PLATED GOLD

DIELECTRIC TEFLON

HEX. NUT BRASS
PLATED GOLD

LOCK WASHER PHOSPHOR BRONZE
PLATED GOLD

WASHER BRASS
PLATED GOLD

PACKAGING
PLASTIC TRAYS

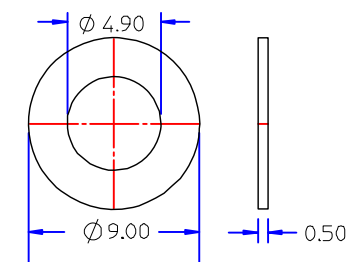
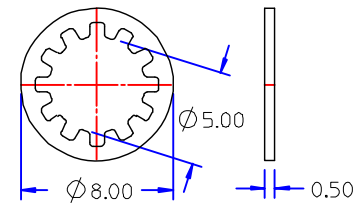
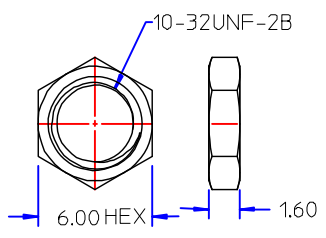
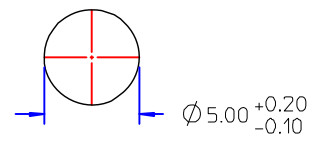

| | | | |
|-----------|------------|-----------|--|
| NOTE: | | Tolerance | 0-6 ±0.10 6-30 ±0.20 30-120 ±0.40 Angular ±1° |
| DRAWN | 2012/11/10 | View | |
| CHECKED | | UNIT | MM |
| APPROVALS | | SCALE | 1:1 |
| John Kine | 12/04.2012 | | |

| | | | |
|--|-----------------------|---|--|
| Dosin Industrial(H.K)Co.Ltd 东莞市德索五金电子制品有限公司 Dosin Hardware Electronics Co.,Ltd | | E-mail:dosin2005@163.com dosin2005@dosin-china.com Web:http://www.dosinconn.com TEL:(0086)769-81153906 FAX:(0086)769-81875836 | |
| Name: | | SMB R/A JACK PCB CONNECTOR | |
| SIZE A | Product NO. | REV | |
| | DOSIN-807-0011 | A | |
| DateTime | CAD FILE | SHEET: 1 OF 1 | |
| 2012/11/02 | D/company drawings/BD | | |

| | | | | |
|----|-------------|----------|---------|-----|
| 3 | INSULATOR | PTFE | NATURAL | 1 |
| 2 | CONTACT PIN | BRASS | GOLD | 1 |
| 1 | BODY | BRASS | NICKEL | 1 |
| NO | DESCRIPTION | MATERIAL | FINISH | QTY |